

Ⓐ OPTIONAL UTILITY SHELF
 - ADD /S TO MODEL NUMBER

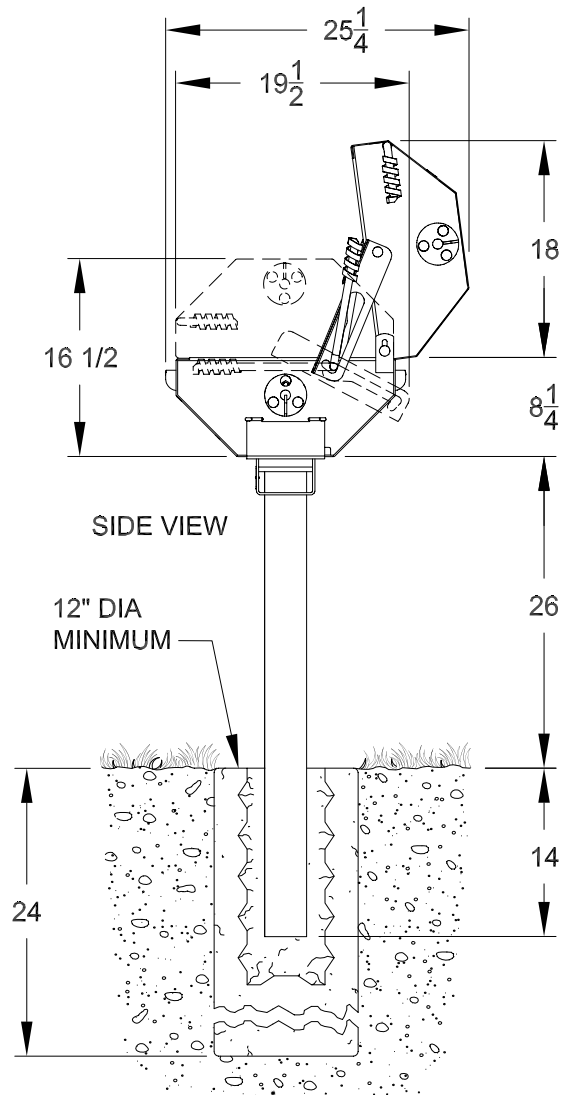
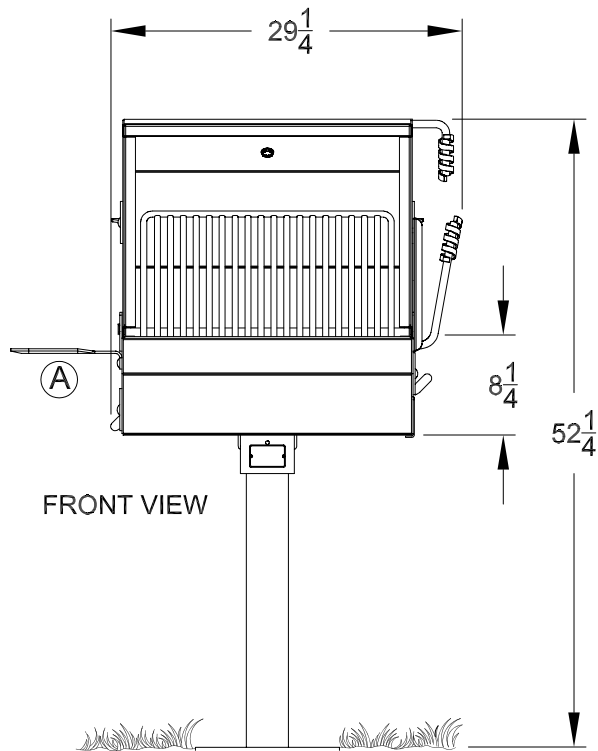
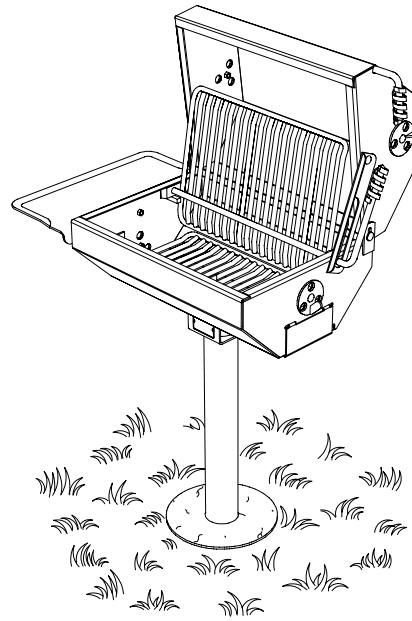
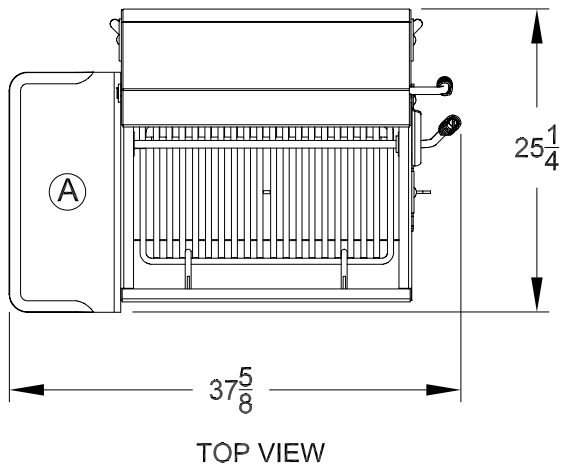

NOTE:
 GRILL SHOWN WITH COVER OPEN AND COOKING GRATE
 TIPPED UP TO SHOW LOWER FIRE GRATE

NOTE:
 LOCAL SOIL CONDITIONS MAY
 REQUIRE A LARGER FOOTING

ALL DIMENSIONS IN INCHES



TITLE EC-26 B2 COVERED PARK GRILL WITH B2 BASE -SHOWN
 WITH OPTIONAL SIDE SHELF

DRAWN BY MGB

DATE 4-8-02

DWG. NO. AI-1464