

Fido Fountain

Mounting: Surface

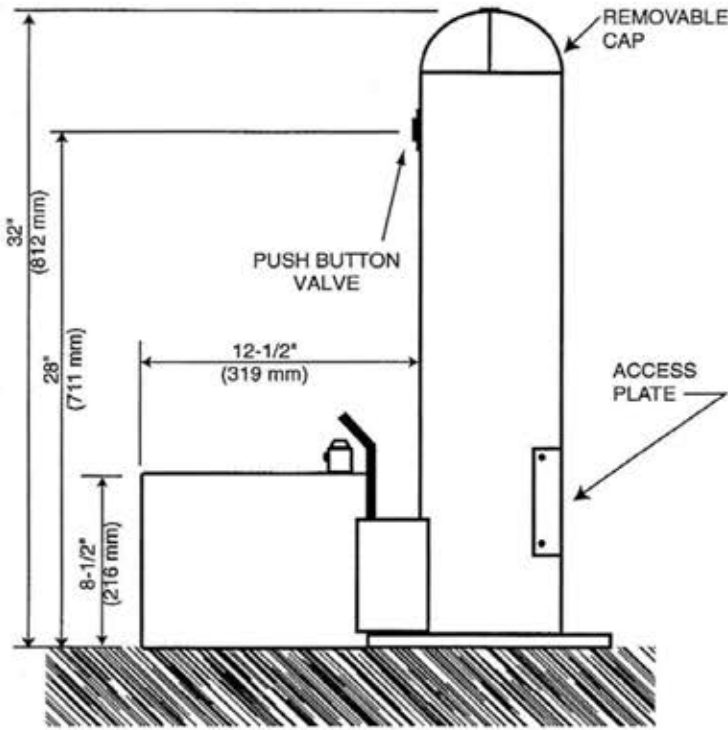

NOTE: FOUR 9/16" O.D. MOUNTING BOLTS SPACED ON 10" DIA. @ 90°

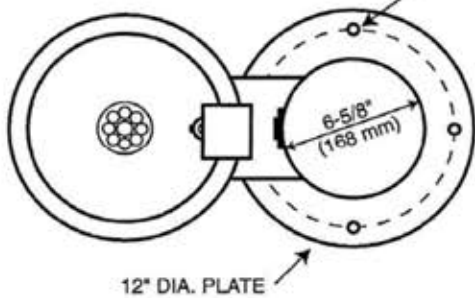

Mounting: In-Ground

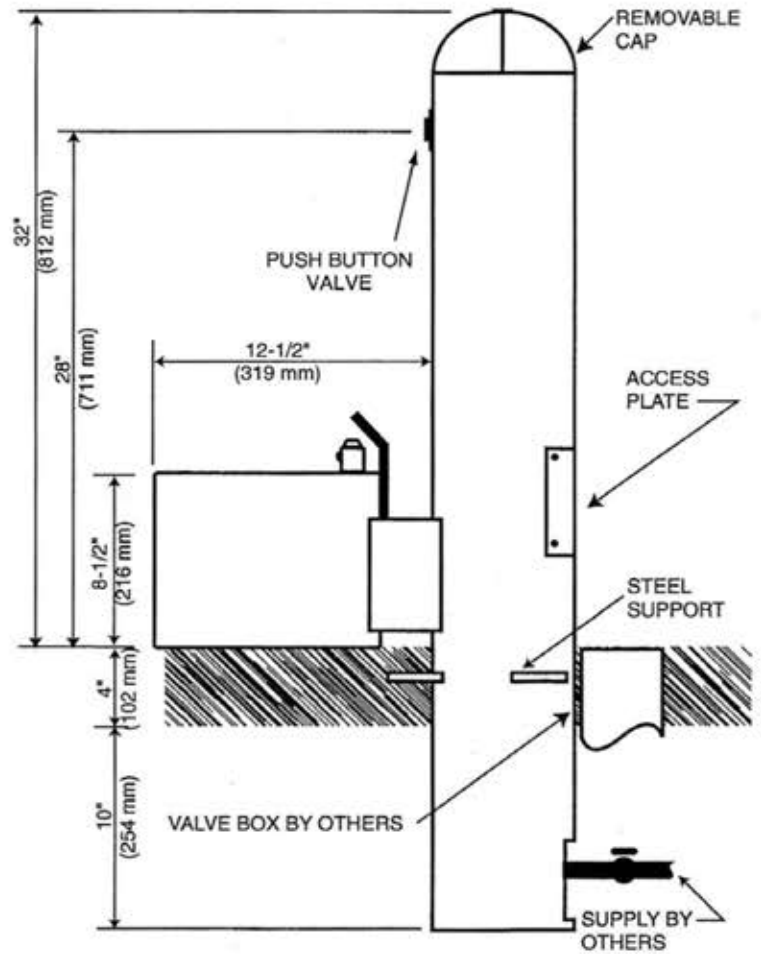

NOTE: THESE ROUGH-IN DIMENSIONS MAY VARY 1/2" (13 mm) PLUS OR MINUS

NOTE: All dimensions subject to manufacturing variance of plus or minus 1/4" (6 mm)

Fido Fountain Specifications

Model:	
Type:	
Pedestal:	6-5/8" diameter steel pipe with .134 wall.
Arm:	3/16" sheet steel arm with attached 10-3/4" diameter pipe projecting 12-1/2" from the pedestal
Receptor:	18 gauge stainless steel with slow draining, pebble guard covered chrome plated brass drain plug.
Spout:	Brushed aluminum, locked to receptor with vandal resistant steel guard.
Valve:	Chrome plated brass push button assembly recessed in 1/2" steel plate with adjustable flow regulation.
Mounting:	Surface. 12" diameter o.d. base plate support with four (4) 9/16" o.d. Bolts
Waste:	1-1/4" flexible hose.
Supply:	1/2" reinforced vinyl tubing with 1/2" IPS hook-up and stainless steel fittings.
Finish:	Polyester powder coat.
Color:	Green. Optional colors: red, blue dark bronze, black, silver, sand, yellow, white, and orange.
Options:	<ul style="list-style-type: none">-32 compression type hose bibb with vacuum breaker-32-SC self closing hose bibb with vacuum breaker-40 plaque-85 valve box-98 leash hook-FP frost proof valve system-SMP-6 surface mounting plate-SS stainless steel-92 spray

GENERAL INSTALLATION MANUAL

For Outdoor Water Products

INSTALLATION INSTRUCTIONS FOR PEDESTAL DRINKING FOUNTAINS

BASIC INSTALLATION

1. Surface Mount - Prior to pouring concrete pad, stub up the 1-1/4" threaded I.P.S. galvanized waste and 1/2" supply pipe to a height of approximately 4 to 6" above finished pad.

In Ground Bury - Prior to pouring concrete, place unit 14" below the surface. Pour a 4" thick concrete pad around the steel supports that are welded to the pedestal.

NOTE: **Be sure to center waste.**

2. To insure proper fountain placement, we recommend using the OPTIONAL mounting plate for the appropriate model (see catalog).

There are two other methods of installing the fasteners for anchoring the fountain in place. Care must be taken in both methods to accurately locate the fasteners. Use either of the following methods:

- a. Locate and secure anchor bolts equally spaced on the bolt circle or plate and equal distant from the centerline of the waste pipe. These bolts should protrude 1-1/4" above the finished grade.

OR

- b. After the slab is poured, locate and drill holes to accommodate 1/2" female thread expansion type concrete anchors. Locate as in method above.
3. Remove the access panels from the drinking fountain, carefully setting them and cap screws aside. Now set the pedestal fountain in place, level and secure mounting plate to concrete pad.
 4. Install 1-1/4" waste nipple to the waste stub, put 1-1/4" slip joint nuts and washers on this waste line. Tighten all connections on the waste line.
 5. Install the 1/2" screwdriver stop on 1/2" supply pipe and before reinstalling the tubing, **flush the supply line thoroughly**. After this is done, connect the tubing to the stop.
 6. Turn on the supply at the screwdriver stop and check for leaks.
 7. Replace the access panels with the stainless steel cap screws.
 8. Stream adjustment, if required, can be done simply by using a 5/32" Hex wrench in to hole in the center of push button.

These fountains are designed to operate on 30 psi to 80 psi pressure. If inlet pressure is above 80 psi, a pressure regulator must be installed in the supply line.

MODELS SW-PBFP, DW-PBFP2, and TW-PBFP UNDER GROUND FREEZE-PROOF VALVE ASSEMBLY

Placement: These units were designed to be installed with pedestal drinking fountains that may be exposed to temperatures below 32 degrees Fahrenheit (F). Contact your local state environmental office for questions on specific drainage code requirements.

Supply: 1/2" NPT with a minimum pressure of 30 PSI, maximum of 80 PSI. If inlet pressure is above 80 PSI, a pressure regulator should be installed in the supply line.

Plumbing requirements: Inlet 1/2" NPT male Waste 1-1/4" O.D. tailpiece

INSTALLATION INSTRUCTIONS

1. Excavate the site for 1/2" supply and 1-1/4" waste connections. The pit must be of a depth to allow for 8 to 12 cubic feet of drainage gravel and the entire plastic casing assembly.
2. Determine the frost line for the region. See the frost proof table on page 5 for appropriate casing assembly pit depths. The bottom portion of the casing assembly pipe should be cut to a length of not less than 28".
3. Connect the supply tubing to the inlet. Be sure that this connection is lower than the regional frost line.
4. Position the 8" schedule 35 plastic pipe in the pit as illustrated on page 5. Apply a plastic adhesive to connect the "Y" fitting to this pipe.
5. With the metal rod provided, bring the supply to the top of the casing. **Always flush the supply line** to remove any particles that may damage the assembly.
6. Lower the complete valve assembly inside of the casing assembly with metal rod provided. While lowering the assembly, be sure to allow the self-coiling supply line to coil below the valve and check for any twists or kinks.
7. Place the cap on the casing assembly. The pit can now be filled.
8. For surface mount installations, locate the fountain anchors in the proper position as illustrated on the inclosed fountain dimensional information sheet.
9. Pour the concrete pad, taking note to allow a 6" sleeve to accommodate both the waste line and the valve arm assembly. After pad has been allowed to dry, position the surface mount fountain on the pad and secure with bolts.
10. Remove the valve assembly from the casing. From the fountain with the supply line connected to the bubbler, insert the supply tubing in the cap hole of the casing arm. From the top of the main casing, pull the tubing to ground level.
11. Cut the supply tubing to a length that will enable the tubing to extend to the base of the casing assembly.

12. Install the fountain waste line as illustrated on page 5.
13. From the air valve, insert the two sections of 1/8" tubing, (**One Black and One Clear**), through the casing arm. With the compression nut provided, attach the black tubing to the push button assembly on the fountain. Attach the clear segment of 1/8" tubing to the black tubing with tape so that it is open ended and allowed to breathe above the ground, inside the pedestal. Note: the clear tubing is an atmospheric vent and has no connection at the surface.
14. Open the shut off valve #2378 with 5/16" hex in the center, (see page 8), and test the fountain for leaks by hand activating the push button.
15. Using the metal rod provided, insert the air valve assembly into the casing assembly. Perform the water test again to check for proper flow. Improper flow can be caused by kinked supply or airlines.
16. Before replacing the valve box cover (supplied by others), check for proper drainage back to the gravel pit below the casing assembly.
17. Failure to comply with the manufactures minimum Valve and Casing assembly requirements will VOID manufactures warranty.

INSTALLATION INSTRUCTIONS FOR OUTDOOR SHOWERS

1. Mounting and supply line plumbing is the same as Page 2.
2. Shower spray pattern is adjustable by use of a 1/8" allen wrench inserted through spray head orifice. Do not force or adjuster will strip out.
3. The shower valves have a present running time of 60 seconds. They can be adjusted from 0 to 2 minutes. Remove access plate located above push button controls. Insert a small screwdriver in \pm head for desired run time.

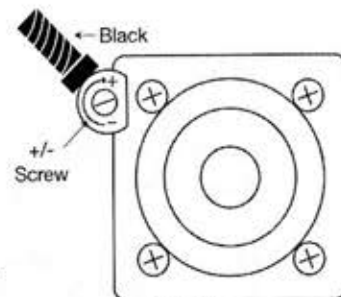

(2192)
Shower Air Valve Configuration.
See Page 8 for Fountain Type

INSTALLATION INSTRUCTIONS FOR WALL-HUNG FOUNTAINS

1. Powder coated metal: 1/2" all threaded rod (4) required for coupling nuts.
2. Stainless steel: Refer to the dimensional information sheet that accompanied the unit for mounting plate or mounting frame detail.
3. Terrazzo and Satinstone: For masonry walls, on mounting bracket provided use 3/8" bolts secured to tap in wall anchors, For non masonry walls, provide adequate wall support for wall plate or support carrier (**optional**).

CAUTION: Do not over tighten mounting bolts. This may result in damage to the unit and void the warranty.

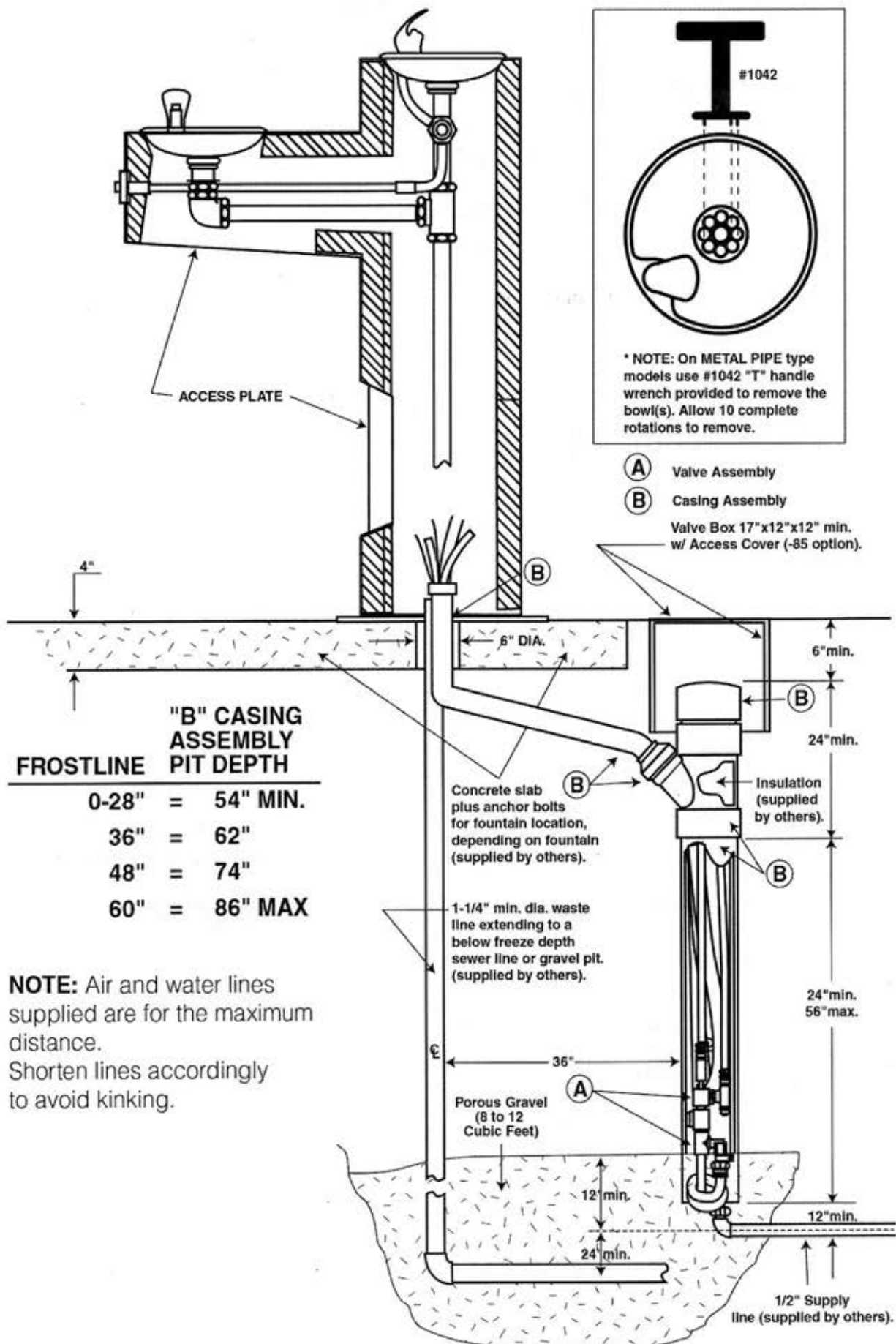

FROSTLINE	"B" CASING ASSEMBLY PIT DEPTH
0-28"	= 54" MIN.
36"	= 62"
48"	= 74"
60"	= 86" MAX

NOTE: Air and water lines supplied are for the maximum distance. Shorten lines accordingly to avoid kinking.

INSTALLATION WITH FREEZE-PROOF VALVE ON WALL MOUNTED DRINKING FOUNTAINS

MODEL-24 FREEZE-PROOF VALVE ASSEMBLY

Placement: This unit was designed to be installed on an inside wall where the temperature will not drop below 50 degrees Fahrenheit (F). Refer to the fountain dimensional data sheets for proper supply and waste locations.

Supply: 1/2" NPT with minimum pressure of 30 PSI, maximum of 80 PSI. If the inlet pressure is above 80 PSI, a pressure regulator should be installed in the supply line.

Wall thickness: 7-1/2" up to 12" on selected models.

Plumbing requirements: Inlet 1/2" NPT Waste 1-1/4" NPT

INSTALLATION INSTRUCTIONS

1. Refer to the dimensional information sheet of the fountain for proper mounting height on the outside wall. Attach the waste line to the fountain and indicate the center of the waste line on the wall. Drill a 1-3/4" hole at the indication.
2. Drill a 1-1/2" hole through the wall for the water supply and a 1/2" hole for the airline activation tubing (see dimensional information on page 7).
3. Position the freeze-proof assembly on the wall with all pre-drilled holes lined up properly. Cut the 1-1/4" tube to a length that will allow the waste to connect from the 1-1/4" elbow on the fountain to the 1-1/4" elbow inside the freeze-proof assembly. Fully tighten the 1-1/4" washers and the slip joint nuts supplied with 1-1/4" elbows.
4. Place a 1/8" pipe sleeve (supplied by others) in the 1/2" hole in the wall. Insert the 1/8" airline tubing and hand tighten it to the compression nut on the push button assembly.
5. Place the 3/8" insulated tubing into a 1" pipe sleeve (supplied by others) that was inserted into the 1-1/2" hole in the wall. Connect the 3/8" tubing to the drain valve fitting inside the freeze-proof assembly. Cut the tubing so that a downward slope from the bubbler to the drain valve fitting is created. The slope must be void of any low spots to prevent ice pellets from forming.
6. **Always flush the supply line** to remove any particles that may damage the assembly. Place the 1/2" supply pipe (supplied by others) through the appropriate side of the assembly. Connect the supply pipe to the 1/2" flexible water line.
7. Place the 1-1/4" waste (supplied by others) through the appropriate side of the assembly. Connect the waste to the trap.
8. Before installing the downward facing louver cover, be sure the 3/8" supply line is properly draining back into the freeze proof assembly when push button is deactivated.

FROST PROOF VALVE TROUBLESHOOTING GUIDE

No Water or Intermittent Flow From Bubbler

1. Remove black plastic air line from push button diaphragm assembly #2199. The push button should produce a blast of air through the diaphragm when depressed. If not, replace #2199 diaphragm only. Note: for models with assembly #2199-B, first verify that part #2280 located inside part #2233 is a minimum 7/8" in length before replacing #2199 diaphragm.
2. Check that the black air line is firmly pushed through the compression nut on #2199 diaphragm. Tighten compression nuts by hand until snug. Lightly tug line to be sure it is firmly attached. Bleeding air will not allow air valve to fully activate.
3. Check that the black air line is attached to the barb fitting on #2192 air valve. If the line is attached incorrectly, sucking on the tube will activate the water flow. If so, reverse the clear and black air lines. Note: the clear line is an atmospheric surface vent that is left unattached above the ground inside of fountain body.
4. Check the air line for kinks. Remove the black air line from #2199 assembly and blow air in the line. If you can continue to blow freely, the line is open and #2192 air valve will audibly click if you are close enough to it. If not, bring the entire valve assembly to the surface to verify. If no audible clicks, the line has a kink or #2192 air valve needs to be replaced or repaired with #2192-RK kit. To determine which is the case, cut the black tubing 3" from #2192 air valve and blow in tubing. If water flows from the bubbler, the air line to #2199 push button has a kink. Follow the black tubing back to #2199 push button or replace entire length of 1/8" tubing. If the water does not flow after blowing in 3" length of tubing replace or repair air valve.
5. Check water line for kinks. Follow water line from #3002 bubbler to #2192 air valve.
6. Check for any water line obstructions in screen located inside #3002 bubbler or inside #2378 stop/strainer that is attached to #2192 air valve. Turn 5/16" Hex located on #2378 stop to shut water off. Remove 4 screws on cap and clean the screen if necessary.

Water Does Not Shut Off

1. The air vent tube is kinked or blocked off by water or dirt in the line. The vent side must be unobstructed for valve to close properly. Vent tube with end cap screen must be positioned above ground inside the fountain body.
2. Replace #2192 air valve or repair with #2192-RK kit.

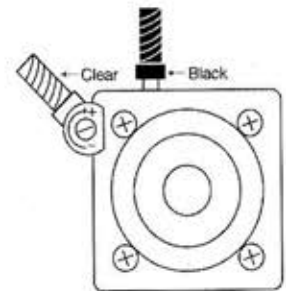

(2192)

Fountain Air Valve Configuration Only

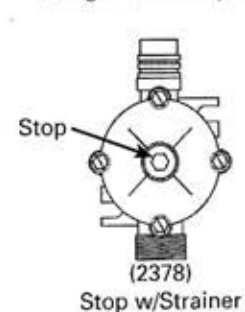
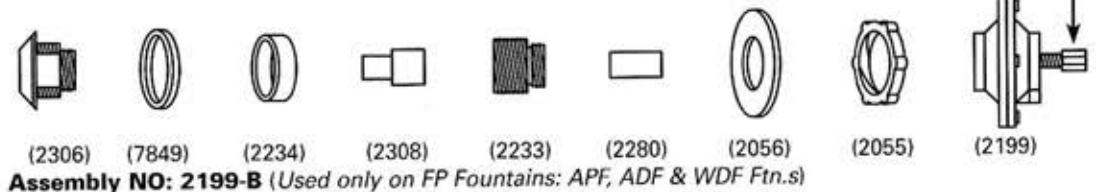
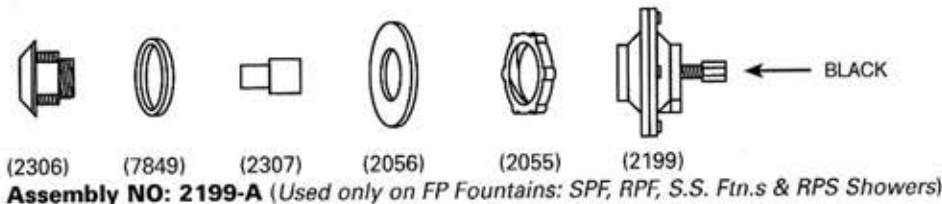

(2378)

Stop w/Strainer

