

PLAN

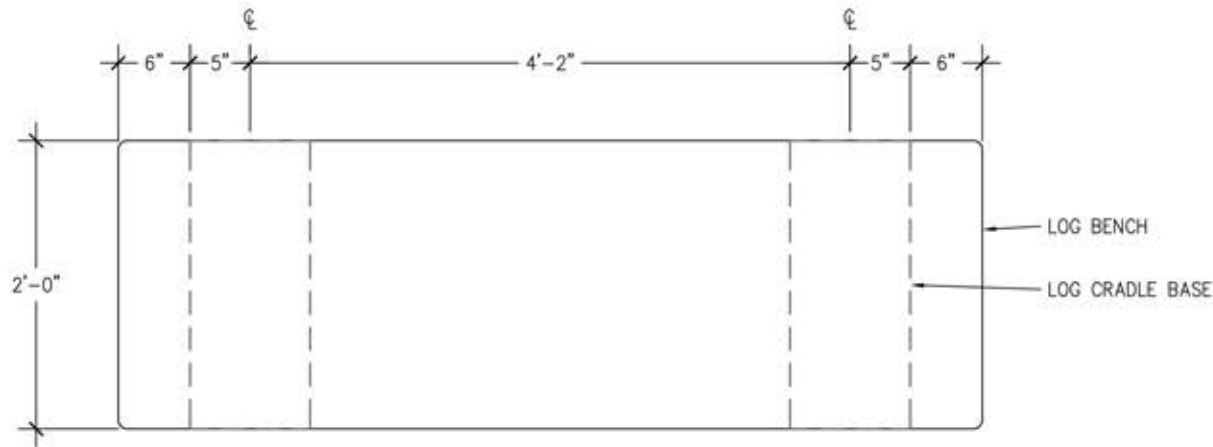

6' Log Bench

6LB



ELEVATION

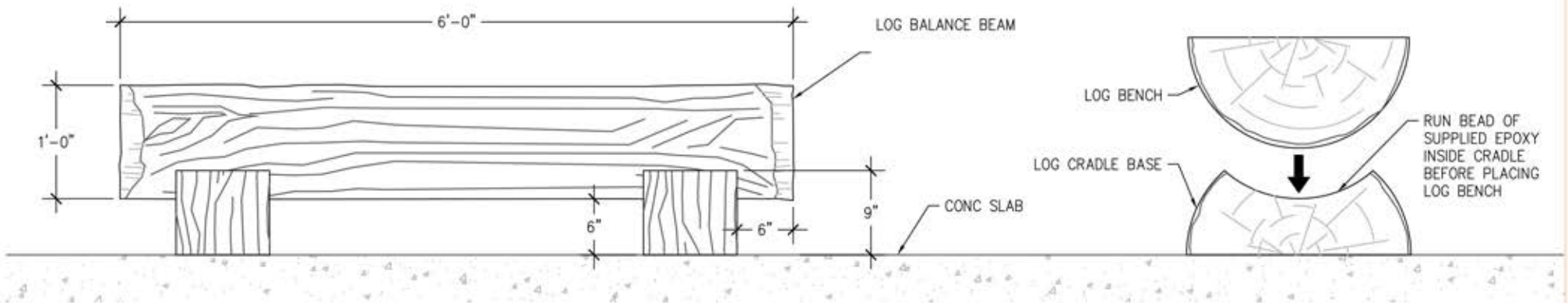

NATURE BARK

INSTALLATION INSTRUCTIONS

Tools Required:

- Skidster or Fork Lift Truck
- Shovel /Auger
- 2 Nylon lifting straps, minimum 8' length
Note: Rated for 1000 lbs. minimum
- Epoxy (supplied by the manufacturer)

Weight: 680 lbs. per Log Bench

Step 1: Thoroughly inspect all pieces before unloading for damages incurred during shipping.

Step 2: Establish layout of Log Bench and place log base cradles as per drawing.

Step 3: Run a bead of the supplied epoxy along the inner cradle.

Step 4: Carefully place Log Bench onto cradle. Make sure piece is centered and level.

Step 5: Once Log Bench has been placed, remove all remaining packaging materials and inspect piece for blemishes. Use included touch-up kit as needed.

GENERAL NOTES

- Due to variables in local soil conditions, footing sizes may vary to meet local codes.
- Actual on-site conditions may vary and may require modifications to installation method.
- Use care and caution while handling play pieces. Make sure all points of contact are protected from lifting straps or other machinery that may damage the piece.
- Bracing materials may be required during installation.

NATURE BARK