

Options:

Note: Options may change without notice.
Call to confirm current options.

Exposed Aggregate (Legs):

Tan w/Gray Matrix - Tan w/Brown Matrix
Tan w/Sand Matrix - Misty Gray w/Gray

Smooth/Stained Concrete (Legs):

Sand - Gray - Brown - Light Charcoal
Red - Yellow - Orange - Cream - Buff - Brick Red

Smooth/Stained Concrete (Seat & Back):

Sand - Gray - Brown - Light Charcoal
Red - Yellow - Orange - Cream - Buff - Brick Red

Custom Options Available

Size: 72" L x 27" W x 33" H.
Weight: 900 lbs.
Seating Capacity: 3-4 persons.
Material: Reinforced Concrete
Reinforcing: 3/8" Dia. steel rebar.
Hardware: (6) - 3/8" Dia. X 3-1/2" stainless steel hex bolts.
(10) - 3/8" Dia stainless steel washers.
(10) - 3/8" Dia. threaded inserts.
(4) - 3/8" Dia. x 2-1/2" stainless steel hex bolts.
(4) - 1/2" Dia threaded inserts.
Anchoring: Optional.
Maintenance: Rinse with water & mild detergent periodically
and re-seal annually.
Packaging: Banded to pallet.
Assembly Required.

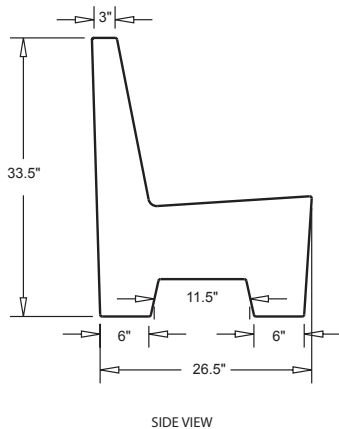
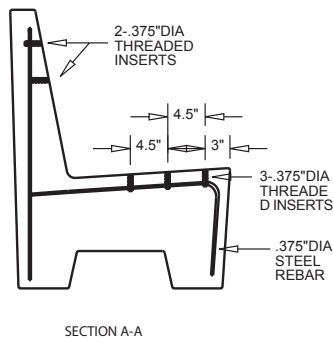
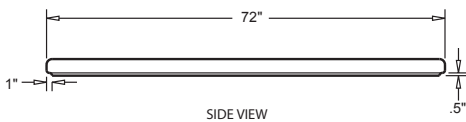
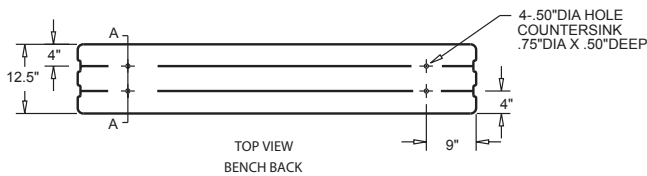
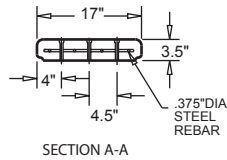
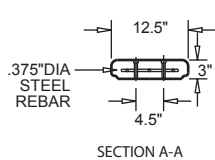
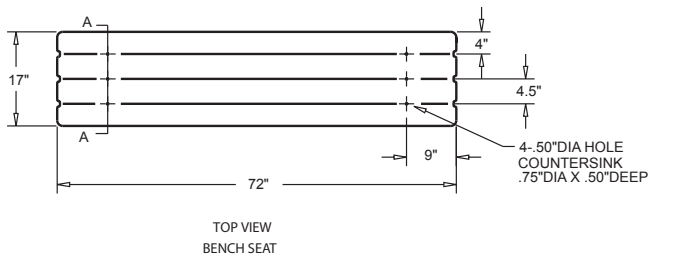

1.1 SUMMARY

- A. Section includes: Furnish Precast Concrete Bench indicated on drawings or specified herein.

1.2 REFERENCES

- A. American Society for Testing & Material
 1. ASTM C33
 2. ASTM C150
 3. ASTM C31

1.5 SUBMITTALS

- A. Submit product data, shop drawings and samples.
 1. Product Data: Manufacturer's specifications and technical data edited specifically for proposed system, including the following specific information:
 - a. Detailed specification of construction fabrication.
 - b. Manufacturer's installation instructions
 - c. Maintenance literature
 - d. Product warranty
 2. Shop Drawings: Indicate pertinent dimensions, general construction, component connections anchoring methods, hardware and installation procedures.
 3. Samples as requested by Architect.

1.6 QUALITY ASSURANCE

- A. Qualifications of Manufacturer: Manufacturer to be prequalified by specifier prior to bidding. Failure to comply will result in disqualification of bid. Manufacturer to have at least five years experience in the manufacturer of precast concrete benches field proven for at least five years.

1.10 WARRANTY

Manufacturer shall submit a written warranty for precast products for the period of two years upon acceptance of products.

2.1 MANUFACTURERS

- A. Acceptable manufacturer for Precast Concrete Benches to be known as Wausau Tile, Inc. Terra-Form Division. P.O. Box 1520 Wausau, WI 54402-1520.

- B. Clarification Note: Drawings and installation specification are based on manufacturers proprietary literature from Wausau Tile, Inc. Other manufacturers shall comply with minimum levels of material and detailing indicated on drawings or specified herein.

2.2 MATERIALS

- A. Portland Cement: ASTM C150 specifications for Portland Cement.
- B. Aggregates: All aggregates to meet ASTM C33 specifications, to be cleaned of foreign matter and properly graded to size.
- C. Coloring: All Precast products for this project shall be of one manufacturer.